

Controlling, operating and
protecting assets in harsh
and hazardous areas

EATON

Powering Business Worldwide

More protection. More technology. Expect more.



De-risk by design

Delivering world-class reliability and safety in high consequence harsh and hazardous environments

MTL products, part of Eaton's Crouse-Hinds series portfolio, stand for safety in the harshest of environments. With over 40 years experience within the process industry, Eaton's MTL product range is designed and manufactured with you in mind. Starting with the MTL100 zener barrier, our comprehensive portfolio of solutions for high-consequence harsh and hazardous environments has grown and gained customer recognition worldwide.

Only Eaton can deliver...

- Protection and safety of people and assets around the world.
- Unsurpassed reliability and quality in every product we offer.
- Industry leading innovation and product efficiency.
- Product solutions designed and certified for global specifications.
- Best-in-class, global sales and customer service teams that provide local support.
- More than 40 years of process automation industry knowledge and expertise.



Contents

MTL scope of supply	6 - 7
MTL SUM5™ Smart Universal Marshalling solution	8 - 9
MTL signal conditioning	10 - 11
MTL intrinsic safety solutions	12 - 15
MTL HART® interfacing	16 - 17
MTL FOUNDATION™ fieldbus solutions	18 - 25
MTL industrial network solutions	26 - 29
MTL network security	30 - 31
MTL surge protection solutions	32 - 35
MTL HMI & visualisation	36 - 41
MTL gas analysers & systems	42 - 43
MTL process alarm equipment	44 - 45
Functional Safety Management	46 - 47
MTL product stewardship	48 - 49
MTL services & support	50 - 51

Many of the world's most safety-critical processes are monitored, controlled or protected by our products



The safety you rely on



Eaton is a leader in reliability, efficiency and safety with the development and supply of our MTL system infrastructure products and protection equipment especially suited for process industries.

Many of the world's most safety-critical processes are monitored, controlled, visualised or protected by our MTL product range and we are distinguished by our global network of sales and support centres, ensuring you are always safe in our hands, wherever you are.

We have a wealth of knowledge and expertise alongside an enviable reputation as a leading global provider of intrinsic safety explosion protection

devices and systems for use in process control applications. Key applications also include fieldbus and industrial network components, HMI and visualisation, surge protection, alarm management and gas analysis. To add to this Eaton is the first provider of process instrumentation to be certified as a Functional Safety Management (FSM) company.

Our MTL product range is used in all types of locations, both hazardous and general purpose; from offshore oil and gas platforms, power production plants and petrochemical installations to pharmaceuticals, telecommunications and other manufacturing/process plants. Dedication to our customers

and recognition of industry requirements continues to drive our development of new products to ensure we deliver the best values and solutions to meet our customers' needs.

At Eaton, we provide one of the world's largest portfolio's of electrical equipment for explosive, classified and industrial areas. Offering unsurpassed product reliability, quality and efficiency with industry-leading innovation and design certified for global specifications. Eaton delivers proven solutions for harsh and hazardous environments.

MTL scope of supply

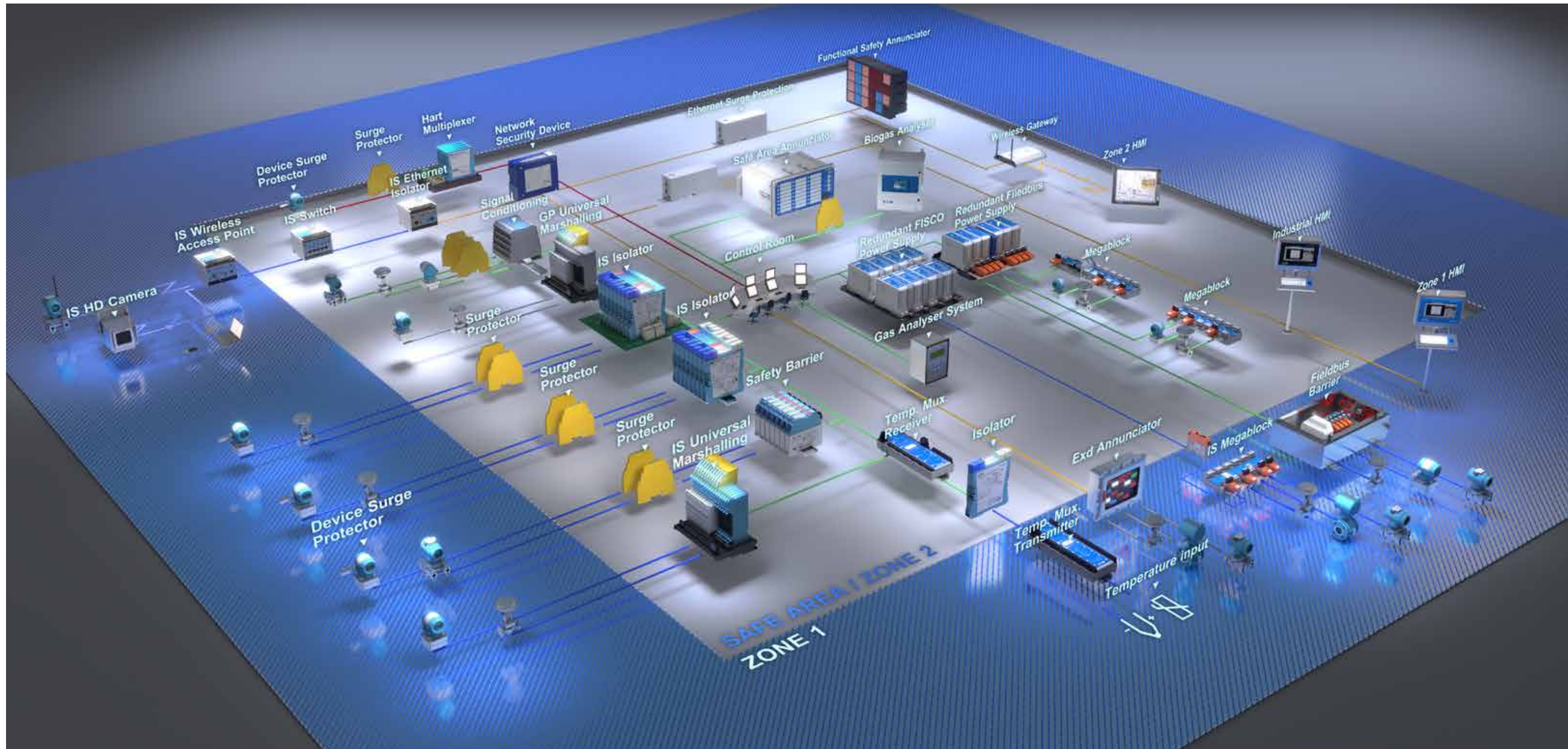

Controlling, operating and protecting assets
in harsh and hazardous areas



Minimize CapEx and maximise investment return



Introducing the MTL SUM5™, a universal marshalling and smart cabinet solution

Eaton's Crouse-Hinds Division now has an innovative and reliable marshalling solution that can reduce DCS cabinet requirements by 30 to 50%, significantly decreasing project infrastructure costs.

With the MTL SUM5, **we've combined five marshalling functions into ONE configurable and standard design.**

- Intrinsically safe isolators
- Signal conditioning
- Relay interfaces
- Surge protection
- Loop disconnect

The MTL SUM5 can typically reduce the number of marshalling component types on a bill of material from 20 to 7, simplifying procurement, commissioning and maintenance.

Plus, with the SUM5's modular design, late changes in I/O or surge can be easily accommodated at minimum cost and time.



MTL SUM5™ Smart Universal Marshalling solution

More detailed MTL SUM5 product information in separate, comprehensive catalogues, datasheets or whitepaper are available from your local Eaton office, or via our website at www.mtl-inst.com

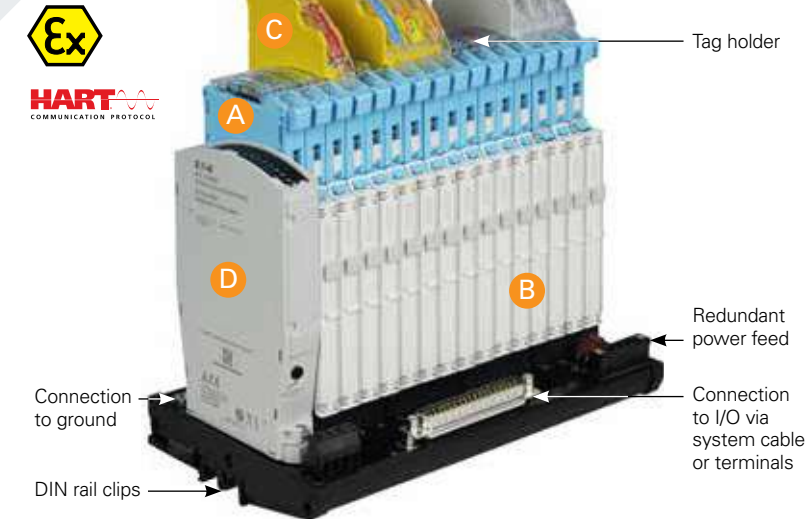

Modular and configurable design reduces costs, optimizes productivity, and increases process up-time

- 5 marshalling functions in ONE design simplifies commissioning, start-up, maintenance and documentation
- Eliminates up to 8 connections per channel, the most common fault in marshalling cabinets
- Comprehensive diagnostics notify you when service is required
- Intelligent modules with LED indicators simplify commissioning and troubleshooting
- Components can be easily replaced. Replacement isolator automatically assumes channel configuration
- Extended -40°C to +70°C operating temperature range
- Designed for ATEX, IECEx and North American certification requirements

Reduce installation costs while saving valuable space in your control room

With the MTL SUM5 you can go from this:

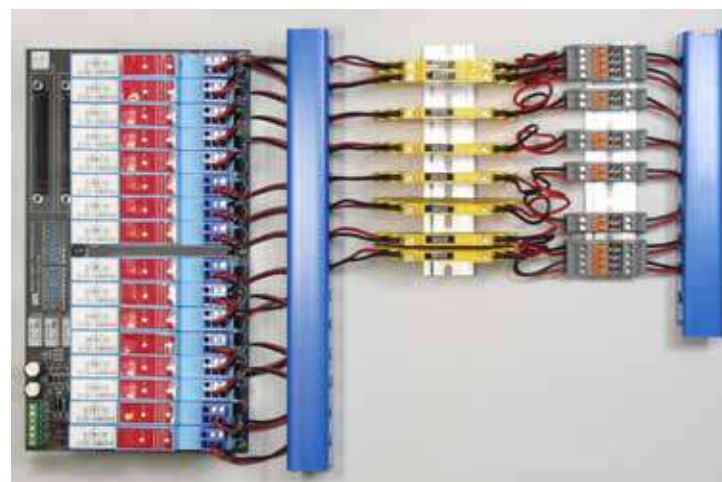

Intrinsic safety isolators

To this:



Each cabinet removed saves 2.2 m² in the rack room and 270 kg in weight!

A Rugged Field Terminal Assembly (FTA)

- Available as intrinsically safe or general purpose versions
- 16 channel carrier with rugged field wiring connections
- Knife disconnect to isolate all four field terminal connections
- Clear plastic tag holder for channel identification



B Isolator Module

- Plugs into IS Field Termination Assembly for intrinsically safe applications or general purpose FTA for signal conditioning applications
- Configurable module for AI, AO, DI, and DO applications. Temperature input module for thermocouple, RTD and mV applications
- Functions can be mixed on the carrier
- Single channel module provides channel-to-channel isolation
- 3 port isolation
- Status and configuration LEDs to simplify commissioning and troubleshooting

C Surge Protection Module

- Proven Hybrid GDT and suppression circuit with fast response and high surge current rating protects marshalling cabinet equipment, I/O, controller, etc.
- Total discharge current of 20kA(8/20μs)
- Add or replace surge protection without changes to the cabinet or wiring
- Uninterrupted signals during module installation and removal
- Surge modules can be easily added after the system is installed and commissioned, saving up-front costs when surge requirements may not be fully defined

D Configuration and Diagnostic Module

- USB connection for simple configuration from PC
- Independently configure multiple field and system modes supporting the widest range of field device and system I/O
- Relays for diagnostic and process alarms. Option of dedicated alarm for each channel
- Connect PC for detailed diagnostics for commissioning and troubleshooting LEDs for channel status

MTL signal conditioning



With process plants now spread over wide areas and the demand for more information, the transfer of electrical signals present many challenges. High power devices mixed in with low level signal transfer generates an environment which has an adverse effect on the ability to control and measure the processes.

Signal conditioning makes a major contribution to resolving issues such as varying grounding potentials, reducing

signal noise and eliminating earth loops. It also protects sensitive control equipment from dangerous voltages. Many different signals from sensors such as thermocouples, RTDs, position monitors, pressure and flow monitors are all accommodated. These benefits add up to reduced down time, fewer failures, greater product yield and significant cost savings.

Signal conditioning is used in many industrial processes, in addition to the industries

Eaton's MTL products are well known for, through our intrinsic safety and process IO portfolio.

We have applied our expertise to the new MTL SUM5 universal marshalling, the MTL1000 range of DIN rail signal conditioners and the MTL4600 range of backplane-mounted signal conditioning isolators, making Eaton your choice as a trusted, single source of supply for all of your interface requirements.



Featured product

NEW

MTL SUM5™ Smart Universal Marshalling

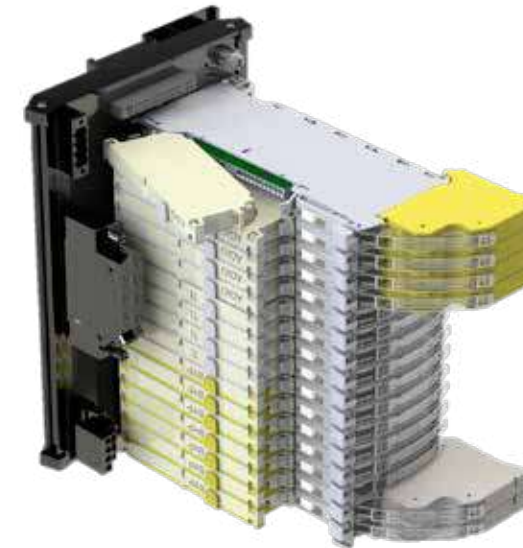

More detailed MTL signal conditioning product information in separate, comprehensive catalogues or datasheets are available from your local Eaton office, or via our website at www.mtl-inst.com

MTL's new generation of universal marshalling supports the widest range of signal conditioning applications. For example, for analogue and discrete inputs and outputs, the universal ADIO module is fully configurable to support the widest range of field devices and system I/O. This reduces the different types of components to be selected, ordered and maintained, simplifying marshalling throughout the plants life cycle. This makes it the optimum solution for both greenfield and retrofit applications.

The backplane mounting MTL SUM5 is the perfect choice for all control systems with the choice of direct integrated cable connections or system terminal connections providing a flexible solution. Each channel can be configured as an input or an output with a choice of operating modes to directly match those of the system.

Signal and system diagnostics are a key feature offering the user fast and precise identification of faults with the system or the field equipment. The modular approach offers the user the ability to fully standardise the cabinet design with the highest possible packing density saving costs for control rooms and infrastructure.

Field wiring is landed directly on the interface terminals. The built in loop disconnect feature, with the universal signal handling, eliminates the need for complex unreliable wiring within marshalling panels. Spare wiring can also be landed without the electronics fitted, to provide for future expansion.

MTL signal conditioners

MTL1000 range



Signal isolators

The MTL1000 range of signal conditioning isolators, trip amplifiers and accessories are designed to help protect field instruments and control systems to provide safe, reliable process communications. This cost-effective solution offers significant savings with its embedded DIN-rail mounted power-bus and compact design. The optional MTL1991 power-bus feed and alarm module offers added power security with the application of dual power feeds with individual supply monitoring.

Backplane mounted signal conditioners for integration into DCS, ESD and fire and gas systems

MTL4600 range



Backplane mounted signal isolators

Building on the base of the MTL4500 range, the MTL4600 offers a high level of signal isolation for installations where multiple loops on a common connection are not desirable. Signal isolation provides excellent protection against surges, common faults and noisy environments. It also eliminates the risk of earth loops between different areas of the plant, which if not isolated, can cause significant errors or failures under fault conditions. The MTL4600 isolators are fully compatible with all existing backplanes used with the MTL4500 range and many control systems. The form factor and signal types offer the user a common approach for both IS and non-IS signals.



MTL intrinsic safety solutions



For over 40 years, Eaton's MTL intrinsic safety interface products have been world leading, with a range of barriers, isolators and integrated IS solutions to help prevent explosions in process industries. Whatever the application, our products help to protect investments in hazardous areas.

The products range from industry renowned IS barriers and isolators through to sophisticated

process control products, all designed for the harsh environments often encountered in the process industry.

As part of our 'customer commitment' process, we regularly produce educational reference material to assist users in understanding the latest regulations and directives.

The intrinsic safety concept simplifies circuits and permits live maintenance within the hazardous area

Featured product

NEW

MTL SUM5™ Smart Universal Marshalling



More detailed MTL Smart universal marshalling product information in separate, comprehensive catalogues or datasheets are available from your local Eaton office, or via our website at www.mtl-inst.com

MTL's new generation of universal marshalling supports the widest range of intrinsically safe applications. For example, for analogue and discrete inputs and outputs, the universal ADIO module is fully configurable to support the widest range of field devices and system I/O. This reduces the different types of components to be selected, ordered and maintained, simplifying marshalling throughout the plants life cycle. This makes it the optimum solution for both greenfield and retrofit applications.

The backplane mounting MTL SUM5 is the perfect choice for all control systems with the choice of direct integrated cable connections or system terminal connections providing a flexible solution. Each channel can be configured as an input or an output with a choice of operating modes to directly match those of the system. Additionally, the IS safety parameters are selectable to provide compatibility with the IS field device and an IS relay terminal option is provided.

Signal and system diagnostics are a key feature offering the user fast and precise identification of faults with the system or the field equipment. The modular approach offers the user the ability to fully standardise the cabinet design with the highest possible packing density saving costs for control rooms and infrastructure.

Field wiring is landed directly on the interface terminals. The built in loop disconnect feature, with the universal signal handling, eliminates the need for complex unreliable wiring within marshalling panels. Spare wiring can also be landed without the electronics fitted, to provide for future expansion.

MTL intrinsic safety isolators

MTL4500 range



MTL5500 range



Backplane mounted intrinsic safety isolators

The MTL4500 range is the next generation of backplane mounting intrinsic safety isolators. Utilising innovative planar transformer technology at its heart and extensive automation in construction, the MTL4500 range offers industry leading features and performance in a single package. It is designed with the requirements of system vendors in mind, for 'project focussed' applications such as Distributed Control Systems (DCS), Emergency Shutdown Systems (ESD) and Fire and Gas monitoring (F&G). With fast module installation, easier system integration, improved performance from low-power circuit designs and more I/O channels in each module giving the highest packing density on the market plus 3 port isolation as standard.

DIN-rail mounted intrinsic safety isolators

The MTL5500 range of intrinsic safety isolators are DIN-rail mounting and meet the needs of the IS interface market for "application focussed" projects. These range from single instrument loops, through various combinations and enclosures to fully equipped cabinets, across all industries where hazardous areas exist. The MTL5500 range has a slim, compact housing and the range of module options contains both single and multiple channel devices which enables the user to choose the functionality and integrity needed without sacrificing cabinet space. The modules can be used for a wide variety of interface tasks for process instrumentation. All signal wiring is made through removable connectors which facilitates fast installation and simple maintenance procedures.

MTL analogue multiplexer system

MTL830C

Temperature Multiplexer system for Zone 0 hazardous area applications

MTL830C analog multiplexer system with Modbus® outputs provide a cost-effective alternative to single-loop isolation. The cost of installed wiring is reduced by up to 50% by communicating the input of multiple hazardous-area sensors over a single twisted pair data highway. Further savings are achieved by reducing the number of inputs to the host, cabinet space and weight.

An analog transmitter, mounted in the hazardous area, supports thermocouple, RTD, potentiometer and mV analog inputs. A compatible safe-area receiver provides serial Modbus® outputs for feeding to host PLC, PC or DCS controllers.

The data highway cable, a simple twisted pair or a pair of wires within a core cable, connects the transmitter

and receiver for carrying both power and data over distances up to 2km. If the analog transmitter is located in the hazardous area, the data highway must be protected by an MTL5553 digital isolator.

Multiplexer systems can communicate the status of up to 32 inputs, reducing the number of hazardous area wiring pairs from 32 to one.

Reduce costs by eliminating long runs of expensive thermocouple compensation cable from the hazardous to the safe area. Also, if 3- or 4-wire RTDs are used, costs are reduced by terminating each RTD at the transmitter or its enclosure. Accessories include stainless-steel enclosures, a USB cable, and a PC-based configuration software package.



Reduce the cost of installing hazardous-area cabling

World leading intrinsic safety interface products

MTL intrinsic safety barriers

MTL7700 range



Din-rail mounted safety barriers

The MTL7700 range follows closely in the footsteps of the MTL700 but as a DIN-rail mounting barrier providing quick and easy installation without the need for special hardware. Removable terminals are used for ease of installation, maintenance and for providing a loop disconnect by simply unplugging the terminals from the side of the module. The barriers clamp simply and securely onto standard T-section DIN rail, simultaneously making a reliable IS earth connection. When the MTL7700 range is used in conjunction with the MTL7798 power feed module the user has a fully protected, electronically fused supply to many barriers with no additional wiring required. The MTL7700 is the replacement for the MTL700 range, which is now terminated. A special adaptor bracket is available to mount the MTL7700 on the MTL700 earth bar.

MTL intrinsically safe indicators

MTL660 range



Loop powered indicators

The MTL660 range of indicators are loop powered units and the low voltage drop across their input terminals allows them to be installed in almost any 2-wire, 4-20mA loop. Large liquid crystal displays make the process variables easily visible at a distance and a backlight option may also be ordered for use in low light conditions. Process units are configured into the display area. Instant readout of percentage or loop current is available at the push of a button. Field mounting units are housed in a rugged aluminium IP67, NEMA 4X case. GRP options are available for highly corrosive atmospheres.

Custom, standard and universal backplanes for easy DCS integration

MTL custom solutions

The MTL SUM5 and MTL4500 range of backplanes, enclosures and other accessories provide comprehensive, flexible and remarkably compact mounting facilities for system vendors, original equipment manufacturers and end users alike.

- Total flexibility
- Special functions
- Reduced wiring
- Signal conditioning
- Simplifies installation
- HART® integration

Customised backplanes

Eaton provides a complete design and manufacturing service for MTL customised backplanes. Customised backplanes give the vendors and users of process control and safety systems the opportunity to integrate MTL SUM5, MTL4500 and MTL HART® modules directly into their system architecture. As there are no hazardous-area circuits on the backplanes, customised versions can be produced without the need for IS certification, so simplifying design and lowering costs.

DCS vendors/systems supported

ABB Automation

S800

Emerson

Delta V, M series, S series

Bentley-Nevada

HIMA

HIMax

Honeywell

PMIO, C200, C300, UPIO, Safety Manager, USIO

Rockwell Automation

ICS Triplex, Plantguard

Schneider Electric

Foxboro, Triconex Trident/Tricon, Modicon

Siemens

ET200, S7

Yokogawa

Centum R3, VP, N-IO, ProSafe RS, SN-IO

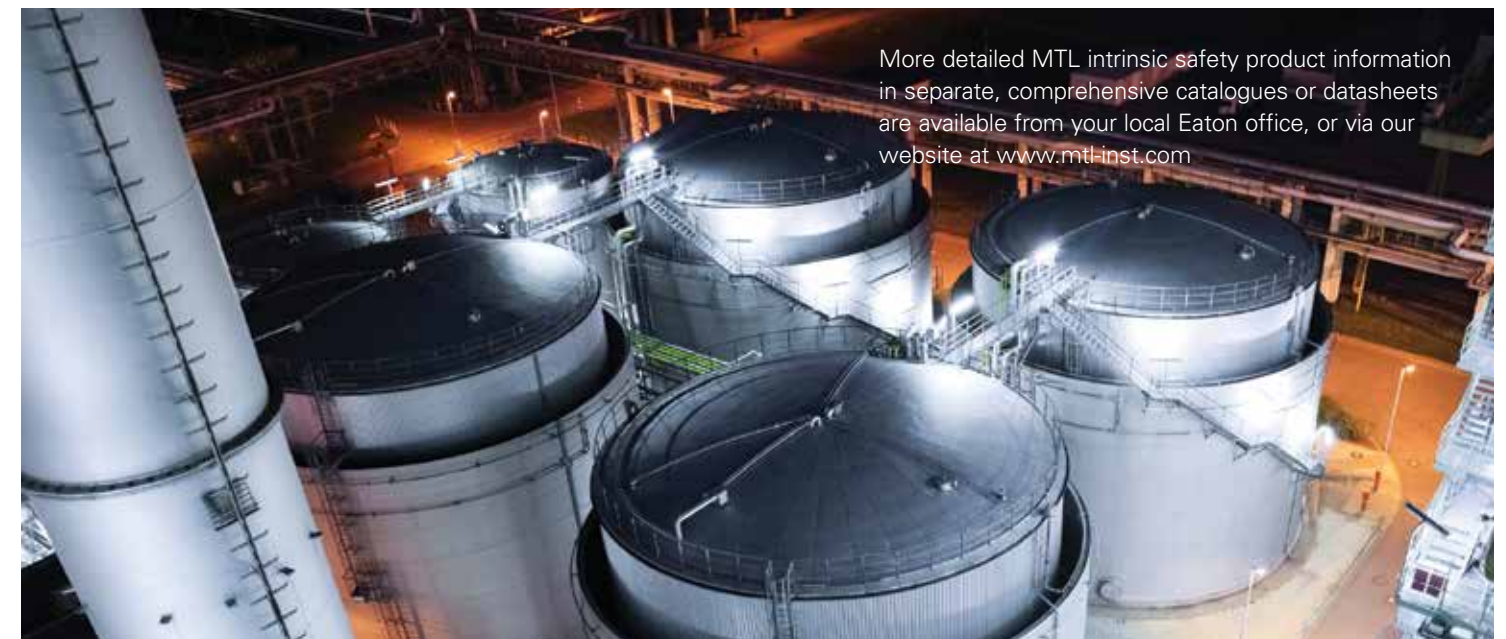

More detailed MTL intrinsic safety product information in separate, comprehensive catalogues or datasheets are available from your local Eaton office, or via our website at www.mtl-inst.com

MTL HART® interfacing

Every HART® field device is capable of providing significant data about its performance and the process it is controlling. Don't ignore such a valuable asset!

If you have smart field devices installed and you are not making full use of their capabilities, then you need our HART® connection system. Our MTL HART® products provide the connections between the

HART® field instruments, the control systems and the process automation maintenance software.

The MTL HART® multiplexer system provides on-line access from a PC to the HART® field devices for monitoring device performance. HART® devices may be selected for regular status monitoring and alerts to be issued if the status changes.

Eaton's MTL solutions for HART® connection systems include a comprehensive range of reliable products, software, services and training



More detailed MTL HART® product information in separate, comprehensive catalogues or datasheets are available from your local Eaton office, or via our website at www.mtl-inst.com

Featured product



MTL multiplexers

MTL4850/MTL4854

HART® multiplexers

The MTL4850 HART® multiplexer provides a simple interface between smart devices in the field, control/safety systems and HART® instrument management software running on a PC. The system is based on 32-channel modularity to provide a compact, easily configurable and expandable system.

The new MTL4854 mounts on the same range of backplanes as the MTL4850 but includes four HART® modems that enable simultaneous communications

with connected field devices to be carried out.

- Designed to mount directly to a range of customised connection units
- MTL4850 designed for use with SIL3 loops (non interfering)
- MTL4854 designed for use in partial-stroke test valve positioner applications
- Connect over 2000 loops on one RS485 network



MTL multiplexers

MTL4851/MTL4852



HART® connection systems

The new MTL4851 and MTL4852 HART® connection system provides a simple interface between smart devices in the field, control systems and HART® instrument management software run on a PC. The system is based on 16-channel modularity to provide a compact, easily configurable and expandable system. Each node on a standard RS485 network can support up to 256 channels through multiple secondary modules controlled by a single master.

- Designed to mount directly to a range of general purpose HART® connection units and IS backplanes
- Provides a simple interface to smart devices in the field
- Connect up to 7936 HART® devices on a single RS485 network
- LED indication for fault diagnosis
- Auto baud rate detection
- Connectivity to HART® configuration and Instrument Management software (IMS)

MTL backplanes

Custom and universal backplanes



System integration

As every plant is different, Eaton offers a wide range of both generic and customised MTL HART® connection boards for all types of installations to offer the optimum solution.

On board isolation, filtering, signal conditioning, labelling and system specific connectors combine to offer customer related solutions. Whatever the application, we have, or can design, an integrated solution to allow simple, flexible and space effective connection to your control system. Installations worldwide show that users everywhere recognise the quality and reliability of our MTL integrated solutions.

MTL FOUNDATION™ fieldbus solutions



FOUNDATION™ fieldbus H1 provides an open, non-proprietary fieldbus network for control systems and field instruments. It is intended primarily for process control, field-level interface and device integration.

H1 is designed to operate on twisted pair instrument cabling and also supports Intrinsically Safe (IS) applications. Each device communicates via an all-digital, two-way communications system.

Eaton provides a comprehensive range of MTL fieldbus power supplies, wiring components, diagnostic tools and displays for FOUNDATION™ fieldbus H1 networks.

Our complete range of MTL fieldbus physical layer components deliver an unrivalled source for system specifiers and all parties involved in the design, installation and commissioning of FOUNDATION™ fieldbus networks.

Solutions to integrate with all fieldbus control system suppliers



Fieldbus topologies for all applications



Energy Limited Trunk (ELT) - the FISCO network in zone 1

FISCO provides the framework for assembling intrinsically safe (IS) fieldbus networks in zone 1 hazardous locations. In a FISCO installation, the fieldbus trunk and all spurs are IS, meaning that 'live-working' may be permitted on any part of the network in the presence of a flammable atmosphere and

without gas-clearance procedures. This characteristic means that FISCO is recognised as the safest of all explosion protection methods, and is frequently chosen where safe activity in hazardous areas is the primary concern.



High Energy Trunk (HET) - the fieldbus barrier network in zone 1

Fieldbus barriers are widely adopted for FOUNDATION™ fieldbus networks where there is a requirement to connect to intrinsically safe field instruments in zone 1 hazardous areas. The advantages of fieldbus barriers, when used

as part of a 'High Energy Trunk' concept, are the ability to support heavily loaded segments and long trunk cable lengths, while retaining the ability to conduct 'live-working' on the intrinsically safe spur connections.

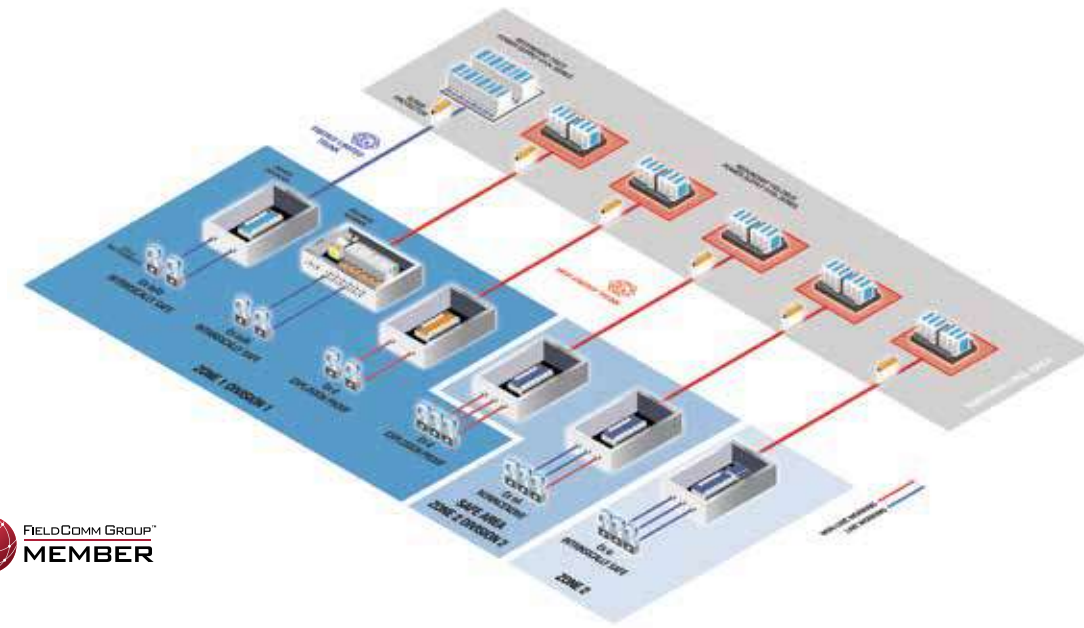

Ex d instrumentation in zone 1/division 1

High Energy Trunk networks provide high levels of power to the field wiring of fieldbus installations, allowing heavily loaded fieldbus segments and extending the overall segment length. When used in hazardous area applications,

the key restriction is that the fieldbus trunk and spur wiring must not be interrupted whilst powered. Where this can be accommodated, High Energy Trunk provides a simple, robust and reliable installation.

The High Energy Trunk network in zone 2/division 2/safe area

This High Energy Trunk architecture is used for general purpose safe area applications. Additionally the device coupler can be mounted in a zone 2 or division 2 hazardous area with connection to Ex nA or Ex d certified field devices.

In division 2 applications, the spurs may be live-worked if the field devices are certified with non-incendive field wiring parameters.

Ex ic in zone 2 hazardous areas

The removal of the 'Ex nL' (energy limited) Ex protection method from the IEC 60079-15 standard, and the introduction of intrinsic safety protection level Ex ic, is driving installers of fieldbus networks to adopt solutions

that support Ex ic spurs. Our solution uses a standard fieldbus I/O and power supply cabinet layout as the Ex ic voltage limiting is located in the fieldbus junction box minimising the size and cost of the control room cabinets.



MTL fieldbus barriers

NEW

Fieldbus barrier, 6/12 spur

The 937x-FB2 fieldbus barrier and the 937x-FB3 compact fieldbus barrier range are field-mounted wiring hubs that create six or twelve intrinsically safe spur connections from a high-energy trunk, for connection to suitably certified FOUNDATION™ fieldbus H1 instruments. Capable of supporting heavily loaded fieldbus segments and long trunk cable lengths, the fieldbus barrier may be installed in zone 1 (gas) or zone 21 (dust) hazardous areas, with the trunk wiring implemented using suitably protected cable and increased safety (Ex e) connection facilities.

Each intrinsically safe spur is capable of supporting a FISCO or 'Entity' certified fieldbus device located in a zone 0 or 1 hazardous area. The short-circuit protected spurs are galvanically isolated from the trunk and require no protective ground connection in the field.

The key modular components of the 937x-FB2 system (fieldbus barriers and surge protectors) may be 'hot-plugged' by design and without gas-clearance procedures or separate isolating switches. This virtually eliminates the risk associated with hazardous area maintenance activities, speeds module replacement and avoids the need for specialist operator training.

- For FOUNDATION™ fieldbus networks in hazardous areas
- Complete enclosure system for 6 or 12 intrinsically safe spur connections
- Mount in zone 1 (gas) or 21 (dust) with spurs connected into zone 0
- Compatible with FISCO and Entity certified fieldbus instruments
- Compact, modular construction
- Ergonomic mechanical design
- Pluggable system components, without 'gas free' constraints
- Optional, integrated surge protection for trunk and spurs

937x-FB2 range



NEW

937x-FB3 range

Compact fieldbus barrier system, 12 spur module

The 9377-FB3-Px Fieldbus Barrier module is a field-mountable wiring hub providing twelve, intrinsically safe, 'simplex', spur connections from a single non-intrinsically safe trunk, for connection to Foundation™ fieldbus H1 fieldbus instruments.



Featured products

Eaton make fieldbus easy in safe and hazardous areas



MTL fieldbus wiring components

Fieldbus Ex ic solution

The removal of the 'Ex nL' (energy limited) Ex protection method from the IEC 60079-15 standard, and the introduction of intrinsic safety protection level Ex ic, is driving installers of fieldbus networks to adopt solutions that support Ex ic spurs.

Eaton's MTL F30 Ex ic adaptor enables such networks to be assembled, when used in conjunction with the 9180 range of 8-segment redundant power supplies and F300 range of megablock device couplers. Typically, one F30 adaptor is used with each fieldbus segment and is installed with the megablock in the field enclosure. Power to the Ex ic segments is provided by 9192-FP modules installed

on the 9180 power supply carriers. When connected to suitably certified fieldbus instruments in zone 2 hazardous areas, the spurs may be live-worked in accordance with normal intrinsic safety procedures. This allows field devices to be connected to the network while it is energised in the hazardous area. Unlike competing products in which the trunk must be treated as a 'partial' intrinsic safety circuit, our solution provides clear separation between the non-arcing (Ex nA) trunk and the intrinsically safe (Ex ic) spurs, thereby avoiding complex rules for wiring in the marshalling cabinet. Further, it is compatible with all host H1 control systems that comply with basic electrical

safety standards, avoiding ambiguous rules for host system approvals.

- Simple compliance with Ex ic certification requirements from control room to field
- No need to assess energy contribution of host H1 card
- Architecture supports Ex nA, Ex d devices and Ex i devices on the same segment
- Satisfies FISCO and entity spur applications
- Supports longer trunk cable lengths for FISCO spur applications



Ex ic adaptor

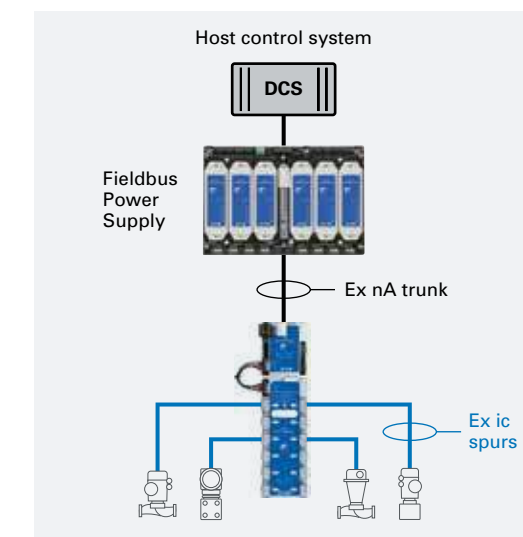

MTL fieldbus power supplies

912x & 910x range



9180-x1 & 9180-x2 range



F10x



FISCO (Fieldbus Intrinsically Safe Concept) power supplies

Eaton's MTL FISCO power supplies have become established as the industry-standard solution for FOUNDATION™ fieldbus installations in which a fully intrinsically safe field network is required. The key benefits of intrinsic safety in fieldbus applications are the ability to carry out live maintenance on any part of the field wiring, and the elimination of complex mixed-protection techniques in the field junction box.

The introduction of power supply redundancy extends the benefits of FISCO into critical hazardous area applications requiring the highest levels of reliability. Such redundancy is routinely specified by knowledgeable end users and engineering companies for fieldbus installations in which failure could result in consequential damage or severe loss of production.

- Simplex (912x range) and redundant (910x range) options
- Safest possible technique in hazardous areas
- Fully live-workable field network
- Up to 265mA segment current
- Field junction box contains simple, highly reliable megablock wiring hub
- Integrated versions for major host control systems
- Redundant power supply option provides unique combination of high system availability and operator safety



Redundant fieldbus power supplies

Our new 918x range of fieldbus power supplies are the first in the market to use an "N+1" architecture to provide redundant power for FOUNDATION™ fieldbus networks, reducing the capital cost per segment by up to 25%.

In contrast with conventional redundancy schemes that use power supply modules in a 1:1 arrangement regardless of actual segment loading, the 918x uses two or three modules per segment depending on the maximum demand current. For segments requiring redundant power up to 250mA - representing a significant proportion of segments in typical fieldbus projects - only two modules are required. The addition of a third module provides redundant power at 500mA.

- Unique "N+1" redundancy - can reduce initial capital cost by 25%
- Fully isolated hot-swappable power modules
- Integrated versions for major host control systems
- Reliable, screw secured pluggable field and power feed connections
- Choice of rising cage clamp screw or spring clamp terminals
- Screen pass-through or ground option without accessories
- On-line physical layer diagnostics option
- Pluggable trunk surge protection option



Single-segment fieldbus power supplies

The F101, F102 and F104 fieldbus power supplies each provide power for a single FOUNDATION™ fieldbus H1 segment.

Galvanic isolation, power conditioning and segment termination are incorporated. The F10x range modules are ideal for all new installations requiring single-segment, non-redundant power in small to medium scale applications such as batch processing.

- Compact design
- Fully isolated
- Low power dissipation
- DIN-rail power bus option
- Low power version for remote, solar-powered applications (F104)



MTL fieldbus wiring components

F300 range



Megablock wiring hubs

The F300 range represents the latest technology in fieldbus wiring hubs, building on three generations of megablock products with an enviable installed base. Providing a simple and reliable means of connecting individual fieldbus instruments to the field network, megablocks protect against spur short-circuits and allow instruments to be easily added to or removed from the segment without disrupting communications.

- Single-piece trunk in/trunk out connector simplifies installation and maintenance
- Spur short circuit protection
- Removable terminator
- Choice of rising cage clamp screw or spring clamp terminals for spurs
- Unique pluggable trunk and spur surge protection option
- Can be installed in zone 2 or division 2 with connections to Ex nA, Ex ec or Ex ic field instruments

F200-IS range

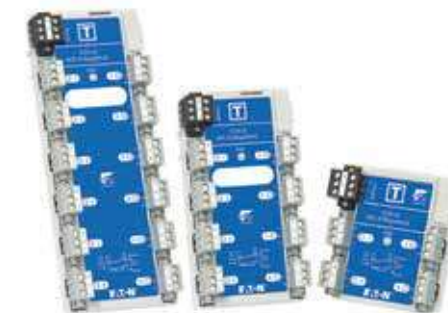

Intrinsically safe megablock wiring hubs

The F200-IS range of megablocks are specifically designed and certified for use in intrinsically safe fieldbus networks. When used with the MTL 912x or 910x range of FISCO power supplies, they allow complete IS segments to be assembled, for connection to field instruments carrying intrinsic safety FISCO certification. 'Entity' certified devices can also be supported using simple adaptors in each spur circuit. As the F200-IS megablocks are part of an intrinsically safe circuit, no special certifications are required for the field enclosure - although Eaton's MTL range of process junction boxes provide excellent environmental protection.

- Certified intrinsically safe for use in FISCO networks
- Compatible with simplex or redundant FISCO power supplies
- Spur short circuit protection
- Choice of rising cage clamp screw or spring clamp terminals for spurs

F200-XE range

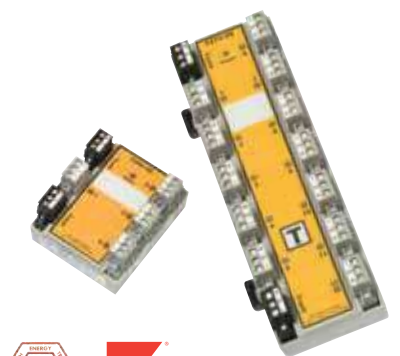

Increased safety megablock wiring hubs

The F200-XE range of megablocks carry certification to the increased safety (Ex e) standard to allow installation in IEC zone 1 hazardous areas.

When mounted inside suitably certified Ex e field enclosures such as Eaton's MTL range of process junction boxes, they avoid the need for heavy and expensive 'flameproof' (Ex d) field enclosures. They are compatible with conventional simplex or redundant fieldbus power supplies as part of 'High Energy Trunk' networks, with spur connections to Ex d certified field instruments.

- Installation in zone 1 hazardous areas in suitably certified Ex e enclosures
- For connection to 'flameproof' (Ex d) field instruments
- Spur short circuit protection
- Choice of rising cage clamp screw or spring clamp terminals for spurs

Low cost safety in hazardous areas, with high reliability

MTL fieldbus barriers

9372-FB

Redundant fieldbus barrier

Fieldbus barriers are widely adopted in FOUNDATION™ fieldbus networks to connect to intrinsically safe instruments in zone 1 hazardous areas.

With fieldbus barriers the requirement for signal isolation and electronics to provide intrinsically safe protection results in lower system availability compared to segments using a simple device coupler. For applications in industries requiring the highest levels of availability, redundant fieldbus barriers can now be specified.

By duplicating the barrier function in the remote field enclosure, the units will tolerate hardware failures without interrupting the operation of the fieldbus segment. In the event of a fault, notification is provided to the host control system, prompting replacement of the failed hardware and the restoration of full redundancy.

- Unique, patented redundant configuration for super-high system availability
- Complete enclosure systems for up to 12 intrinsically safe spur connections
- Failure alarm direct to host control system via integrated fieldbus device
- Supports full feature set of class-leading 9370-FB range
- Live-pluggable system components, without 'gas free' constraints
- Optional, integrated surge protection for trunk and spurs



Maximum availability for your critical loops

MTL fieldbus diagnostic tools



F809F-Plus

Diagnostic module

The F809F-Plus fieldbus diagnostics module monitors the performance of up to eight fieldbus segments providing information on network health. During commissioning, the F809F-Plus collects data on the performance of the physical layer, provides alarms if any parameter is outside the preset limits, and stores a baseline segment performance within the Instrument Management Software.



FBT-6

Fieldbus monitor

The fieldbus monitor, FBT-6, is used to examine the operation of a live FOUNDATION™ fieldbus network without interfering with its operation. The FBT-6-PA Profibus PA diagnostic monitor can be used to examine the operation of a live Profibus-PA segment without interfering with its operation. These monitors are intended for maintenance personnel to verify network operation or to troubleshoot an errant network.



MTL fieldbus devices & accessories



BAx range

Fieldbus H1 & Profibus PA displays

Eaton supplies the widest range of fieldbus displays from 8 variable to cost effective single variable versions, field and panel mount variants, safe and hazardous area versions as well as FOUNDATION™ fieldbus H1 and Profibus PA versions. All versions are bus powered to simplify installation.



FCS range

Enclosures

Eaton has access to a complete range of steel and GRP enclosures and is able to supply complete, engineered solutions for megablocks and other field wiring components. Detailed specifications can be met for accessories and internal wiring, minimising the engineering and project management burden. Eaton's Crouse-Hinds series enclosures are internationally respected and often pre-qualified by end users and plant operators.



Surge protection devices

Surge protection

The design and manufacture of surge protection devices has been one of our strengths for many years. They afford the highest level of protection for complete networks, to defend control systems and associated fieldbus instruments from surges entering through the fieldbus trunk or spurs. Many of our MTL fieldbus products are supplied as standard with the ability to accommodate optional surge protectors, with the benefit of reduced engineering and wiring costs.

More detailed MTL fieldbus product information in separate, comprehensive catalogues or datasheets are available from your local Eaton office, or via our website at www.mtl-inst.com





MTL industrial network solutions



In today's process industries there are increasing demands for greater efficiency, higher reliability and lower cost of ownership of field equipment and supporting networks. Eaton offers end to end or part solutions to meet the requirements of your project.

Eaton is proud to present its range of MTL industrial-strength networking products.

Designed to meet the most demanding process applications worldwide, our portfolio of ruggedised Ethernet connectivity devices offer harsh and hazardous area classifications, combined with our 40 year pedigree of understanding process industry requirements.

Robust, versatile and reliable connectivity for harsh process control environments

Intrinsically safe Ethernet

For applications requiring access into zone 1 and zone 0 hazardous areas, including wireless access, then look no further than Eaton's MTL intrinsically safe Ethernet range. The MTL IS Ethernet range delivers

intrinsically safe "Power over Ethernet" (PoEx™) with a single Cat 5e or Cat 6 cable, allowing live connection and disconnection of the end device in zone 0 or zone 1.

Industrial security system

The move to open standards such as Ethernet, TCP/IP web technologies combined with greater plant integration, has seen a growing number of network security incidents affecting critical infrastructure and manufacturing industries. The MTL Tofino™

industrial security system is a unique solution that addresses the important issue of protecting industrial networks from modern cyber-security attacks.

MTL intrinsically safe Ethernet

NEW

9474-ET(G)/BxLAN

Intrinsically safe Ethernet interface

The unique 9474-ET/ETG interface provides compatible IS signal parameters to allow interconnection to other IS Ethernet devices, simplifying connectivity between non-IS and IS Ethernet devices. The BxLAN is available in versions to suit different applications.

Boxed Types:

- 9474-ET 10/100Mbps Ethernet Interface
- 9474-ETG 10/100/1000Mbps Gigabit Ethernet Interface

OEM PCB Type:

- BxLAN 10/100Mbps Ethernet Interface

- ATEX / IECEx certified
- Compact dimensions
- DIN-rail mounting (cased version)
- Suitable for safe area mounting
- OEM version for incorporating into other designs
- Loop powered
- Ta = -40°C to +70°C



HD IS Ethernet network camera

Eaton's MTL RUGICAM high definition (HD) IS Ethernet network camera and accessories enable plant managers across process industries worldwide to ensure they are operating safely in hazardous zone 1 and zone 2 areas.

The first of its kind for the hazardous area market, the lightweight MTL RUGICAM camera monitors and provides enhanced visual safety to control and automation systems installed on site, and provides additional security and visibility to specific hazardous locations in plants so safe operation can be maintained. Connecting directly to compatible IS Ethernet systems up to 100 metres via a Cat5e cable or WiFi, allows for quick and easy maintenance, enabling plants to save time and associated costs.

- Rugged case with 6mm toughened glass for harsh environments
- IS approval allows for safe, live network maintenance
- HD resolution of 1080p and enhanced image analysis
- Supports live video streaming via a H.264 compressed video format and motion JPEG with user-selectable frame rates
- Micro-SD card slot that can be used as an optional back-up
- Available with an optional Infra-Red (IR) or white LED lights unit that enhances the camera's low light capabilities



MTL RUGICAM-IP

MTL intrinsically safe Ethernet

MTL ExLAN



PoEx

Intrinsically safe 10/100 Ethernet interface

The MTL ExLAN is a simple and compact Intrinsically Safe (IS) 10/100Mbps Ethernet Interface intended to simplify OEM product design and certification. The MTL ExLAN module can be integrated into your IS instrumentation design to power and communicate with the device over an IS Ethernet network. As well as providing the essential LAN interface, the module voltage clamps the equipment's main supply rail together to ensure the Ethernet signals generated are limited to low intrinsically safe levels. It is fully compatible with PoEx™ technology and our 9400 MTL IS Ethernet range.

- 10/100 BASE-T IS Ethernet Interface for standard Cat5e/Cat6 Ethernet cabling systems
- Compact design at 40mm x 40mm x 8mm for easy installation
- -40°C to +70°C operating temperature, designed for harsh environments
- Voltage clamping circuitry for increased safety
- Fully compatible with PoEx™ (Power over IS Ethernet)
- Intrinsically safe ATEX / IECEx component certification

9468-ET



PoEx

Isolator

The 9468-ET 10/100Mbps, isolating Ethernet barrier allows the interconnection of a zone 2 or un-certified safe area device to the intrinsically safe 9400-ET range of Ethernet networking products operating in the hazardous area. The isolating barrier provides a compact alternative solution to fibre optic cable and media converters and for when it is desirable to use Cat5e cables in preference to fibre.

- Zone 2 mountable for connections to zone 0 and 1
- Galvanically isolated RJ45 ports
- Transparent operation
- Compact alternative solution to fibre optics and media converters
- ATEX / IECEx certified
- FM / FMC approved
- Wide temp. range -20°C to +70°C
- Single 20–30V DC power supply
- Status LEDs to show activity

9469-ETplus



PoEx

Wireless access unit

The 9469-ET is a multi-functional module that can be used as an access point, wireless bridge (client) or wireless repeater. When used in the Access Point (AP) mode, it allows wireless devices to connect through it onto the wired Ethernet network, either in AD-HOC or infrastructure modes. When used as a bridge, it makes it possible to turn any 10/100 Ethernet device into a wireless device. Additionally the module may also be used in its Wireless Repeater (WDS) mode to extend the range covered by a wireless network.

- Tri-Band operation
- Convert Ethernet device to wireless
- Zone 1, division 1 mountable in suitable enclosure
- 10/100Mbps Ethernet
- ATEX / IECEx certified
- FM / FMC approved
- Wide temp. range -20°C to +60°C
- PoEx™ power over IS Ethernet

New Gigabit IS Ethernet range (947x-ETG) is planned to be released by the end of 2020. Please contact MTL product line team for further information on this.

Safe, live-workable connections into zone 1

9465-ET



PoEx

Media converter

The 9465-ET 10/100Mbps copper to fibre optic media converter allows an Ethernet network to be extended over a greater distance. The fibre optic link may be up to 8km in length when running at 100Mbps. Longer distances are obtained by simply connecting a 9466-ET (10/100Mbps Ethernet switch) between two 9465 media converters, effectively giving a 'repeater' function.

- Copper to fibre optic converter
- 10/100Mbps wire speed
- Extend up to 5km (10Mbps)
- Zone 1, division 1 mountable in suitable enclosure
- Transparent operation
- Choice of fibre optic connection styles
- ATEX / IECEx certified
- FM / FMC approved
- Wide temp. range -20°C to +70°C
- PoEx™ Power over IS Ethernet

9466-ET



PoEx

Switch module

The 9466-ET 10/100Mbps, layer 2, Ethernet switch allows the interconnection of MTL 9400-ET range of networking modules via its five ports. It also enables an Ethernet network to cover a greater distance using either Cat5e cable or fibre-optic for longer spans. This capability is due to the low latency 'store and forward' mechanism integral to the switch, which ensures that the stringent timing associated with Ethernet is maintained.

- 5-port 10/100Mbps links
- Zone 1, division 1 mountable in suitable enclosure
- Broadcast "storm" protection
- ATEX / IECEx certified
- FM / FMC approved
- Wide temp. range -20°C to +70°C
- Half/full duplex
- PoEx™ power over IS Ethernet

MTL intrinsically safe power supplies

949x-PS-Plus



PoEx

IS isolated power supplies

The 949x-PS-Plus range of MTL intrinsically safe (IS) isolated power supplies are ideal for providing power to instrumentation in hazardous process areas. They offer a wide range of different IS output voltages, ranging from 4.8V - 17.7V, offering flexibility of options to best suit a variety of applications. The 949x-PS-Plus range can also be used with the 946x-ET range of MTL IS Ethernet devices to provide direct power or IS Power over Ethernet (PoEx™), a method which allows a single cable to provide both the data connection and electrical power to devices, in turn, reducing installation costs.

- Wide range of output voltages 4.8V - 17.7V
- Suitable for connections in Gas Group IIB or Gas Group IIC hazardous areas
- Wide operating temperature range of -40°C to +70°C
- Zone 2 mountable
- DIN-rail or backplane mounting
- ATEX / IECEx certified



MTL network security

Supervisory Control and Data Acquisition (SCADA) and industrial control systems have long been considered immune to the cyber attacks suffered by corporate information systems.

The move to open standards such as Ethernet TCP/IP and web technologies has seen control systems affected by a growing number of both

malicious and non-malicious network security events impacting critical infrastructure and manufacturing industries.

The MTL Tofino™ industrial security system is a unique solution that addresses the important issue of protecting industrial networks from modern cyber-security attacks.

Protecting industrial networks from cyber-security threats



More detailed MTL network security product information in separate, comprehensive catalogues or datasheets are available from your local Eaton office, or via our website at www.mtl-inst.com

Featured product

MTL industrial security

9202-ETS

MTL Tofino™ Ethernet based industrial security appliance

Protect your control system against network problems and cyber threats. You may never be attacked by a serious hacker, but typical control networks are extremely vulnerable to simple day to day security and reliability issues. Poor network segmentation, unprotected points of entry into the network, 'soft' targets such as un-patched PCs and vulnerable PLCs, and human error can result in significant production losses and even safety issues.

The 9202-ETS is our next generation MTL Tofino security solution and continues to provide the highest level of network security for process automation applications. It is exceptionally easy to install compared with alternative solutions and includes the latest configurator software to protect industrial networks from cyber-security vulnerabilities. This maximises plant uptime and process availability while protecting it from external network attack.

The MTL Tofino solution is a distributed system with a flexible architecture that allows you to create security zones throughout your control network to protect critical system components. It supports all popular industrial protocols with the Firewall Loadable Security Module (LSM) which compares network traffic against a set of rules. The addition of the new EtherNet/IP Enforcer LSM for deep packet inspection of EtherNet/IP (CIP) communications provides additional protection for this popular industrial protocol.

The MTL Tofino can also be configured remotely with the Netconnect LSM, providing further flexibility. Further LSM's can also be specified such as the Modbus enforcer and OPC enforcer LSMs providing deep packet inspection for these key industrial protocols and the Event Logger LSM logs security events and sends alarms.

- Robust metal housing designed for harsh industrial environments
- DIN-rail mounting for quick and simple installation
- Plug 'n' play devices for immediate protection and no pre-configuration upon installation
- -40°C to +70°C operating temperature
- Free Windows-based Tofino configurator software with intuitive user-friendly interface
- Unique 'test' mode allows firewall testing with no risk to operations
- Compatible with all DCS, PLC, SCADA, networking, and software products
- Class 1 division 2 and ATEX zone 2 hazardous area approvals
- Meets and exceeds NERC CIP requirements and ANSI/ISA-99 standards



Zones and conduits provide defence in depth

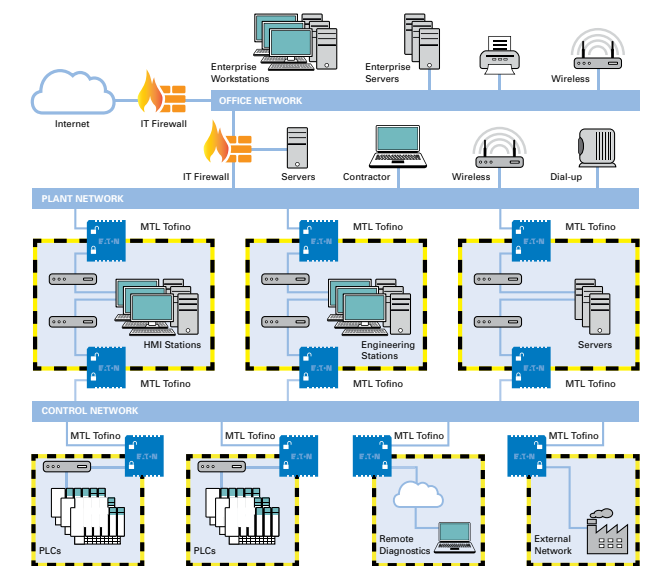

MTL surge protection solutions

Eaton supplies a comprehensive range of MTL surge protection devices offering solutions for mains power, process control, network and communications, telecom, wireless and RF systems.

Correctly applied, surge protection can reduce equipment failure and increase plant availability, thus allowing the maintenance team to perform a more proactive role. Direct cost savings are achieved through the reduction in premature failures and elimination of catastrophic failures resulting in plant downtime.

Our commitment to not only meet, but surpass our customers' high expectations can only be achieved by maintaining very high standards in all aspects of our business. Independent verification of our quality and safety procedures is of paramount importance and our accreditation to internationally recognised standards such as ISO 9001 is proof of this commitment.

Our 10 year 'no-fuss' product warranty, is even further evidence of our confidence in our products and their application capabilities.

Over 50 years experience in protecting critical operations worldwide

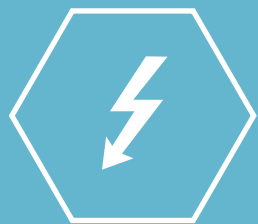

Featured product

NEW

MTL data and signal surge protection

MTL4-SD surge protection for SUM5™

MTL SUM5 surge protection can be added to any loops without disturbing the wiring. The MTL4-SD module is mounted onto the top of the field terminal by lifting the tag holder out of the way and plugging it in. The tag holder can now be clipped back onto the surge module.

The MTL4-SD module can be removed and replaced without interrupting the process signal. The MTL4-SDR Surge protection is used when the MTL4-BSISR or MTL4-BSGPR relay terminal bases are fitted.

Proven Hybrid GDT and suppression circuit with fast response and

high surge current rating protects marshalling cabinet equipment, I/O, controller, etc.

- Total discharge current of 20kA
- Add or replace surge protection without changes to the cabinet or wiring
- Uninterrupted signals during module installation and removal
- Surge modules can be easily added after the system is installed and commissioned, saving up-front costs when surge requirements may not be fully defined



MTL4-SD surge protection



MTL data and signal surge protection

MTL SD Modular (SDM) range

Modular surge device for I/O loops

Based on the proven reliability of the well established MTL SD range, the MTL SD Modular (SDM) surge device brings additional features designed to reduce cost, optimise productivity and increase plant safety.

The MTL SD Modular has a compact 7mm footprint, enabling high packing density and reduced cabinet space, whilst providing a powerful 20kA market leading level of protection. Its modular design allows easy maintenance with on-board LED diagnostics prompting operators when replacement of a module is required. This change can be achieved quickly without the use of tools or need to disconnect the device.

The 'make before break' feature ensures no interruption to the signal current during the removal of the module. The MTL SD Modular is backwards compatible with the popular MTL SD range to make upgrading easy.

Available in 7v, 16v, 32v and 55v variants with a current capacity of 700mA, the MTL SD Modular represents a significant step forward in surge protection suited to a wide variety of process control applications.

- Slim, modular, space-saving design
- High-performing 20kA level of protection
- LED for quick fault diagnostics
- Proven multi-stage hybrid functionality
- Make before break for signal continuity
- Fuse disconnect options for ease of test and commissioning
- Voltage ratings to suit process I/O applications
- ATEX certified, IECEx approval and suitable for use in SIL3 loops
- 10 year no-fuss warranty



Surge protection for your valuable instrumentation and control systems

MTL data and signal surge protection

MTL data surge tester



Test analyser for data communication surge protectors

The MTL data surge tester is a versatile and compact, bench-top test device designed to give performance status of data communication surge protectors. This portable, rugged tester makes continuity and current leakage tests of data surge devices quick and easy during routine maintenance, with LED's illuminating to indicate surge

module health. This in turn allows users to quickly determine whether the surge protection device has failed or degraded in performance to an unacceptable level. These tests validate the integrity of the surge protection system, thus ensuring safety and a continuous high-level of protection.

MTL fieldbus surge protection

FP32 range



Din-rail mounted surge protection for fieldbus systems

FP32 devices provide surge protection, along the trunk or spurs of fieldbus systems, from damaging the associated electronics such as terminators, spur blocks and the bus control equipment. Fully automatic, the FP32 reacts immediately to ensure that equipment is never exposed to damaging surges by directing surges safely to earth and then resetting automatically.

- Meets the requirements of IEC61158-2:2000 for FOUNDATION™ fieldbus
- Plug connectors for quick and easy connection or rewiring
- 20kA maximum surge current
- FM, CSA, FISCO and ATEX approved
- Lloyds approval



Surge protection for fieldbus components

The FS32 surge protection device prevents surges and transient over-voltages conducted along the trunk or spurs of fieldbus systems from damaging the associated electronics such as terminators, spur blocks and the bus control equipment. In operation the FS32 does not adversely affect the performance or operation of the fieldbus or connected equipment, and allows signals to pass with little attenuation.

- Protects IS spurs on MTL 937x-FB range of fieldbus barriers
- 20kA maximum surge current per line
- Plug connectors for quick and easy connection or rewiring
- Meets the requirements of IEC61158-2:2004
- Can be used on MTL megablocks or other fieldbus equipment

FS32 range



TP32 & TP48 ranges



Fieldbus specific surge protector

The TP32 is specifically designed to protect process transmitters and devices on fieldbus systems, meeting the requirements of IEC61158-2:2000 and ANSI/ISA-50.02-2 1992. The TP32 is a hybrid design consisting of high-power, solid state electronics and a gas discharge tube which is capable of diverting surges up to 10kA.

Surge protection for field transmitters

The TP48 safeguards field-mounted process transmitters where it matters, right at the unit. Easy to install and providing high-level protection against surges and transients whilst normal operation remains unaffected. The TP48 resets itself automatically after each operation. The TP48 is available with screw threads to suit different transmitters, with explosion proof and intrinsically safe options for hazardous areas. Working voltage is 48V DC maximum with impulse ratings of 10kA peak current and 10kV peak voltage.

MA15 range



AC and DC power surge suppressor and filter

The MA15 and MA15E range was designed to protect electronic equipment and computer networks against the effects of 'noise pollution' induced in power supplies. These units clean up the effects of industrial noise and surges caused by lightning, switching devices, thyristor controls, transmission system overloads and power-factor correction circuits. MA15 range is UL1449, 4th edition recognised components (certified by UL for both US and Canadian requirements), and MA15E range for ATEX and IECEx approval for mounting in Zone 2 hazardous area, typically inside remote I/O cabinets. Both the ranges exceeds the requirements of IEC 61000-4-5.

- Protects panel loads up to 15 amps in series, unlimited amps in parallel
- Suitable for AC or DC applications
- Thermal and short circuit protection

Other MTL surge protection products

LS Range



Data and signal surge protection

Induced surges and transient voltages can destroy or, perhaps more worryingly, render inaccurate sensitive control and measurement instruments. Control systems, sensors and telecommunications equipment may be subjected to a barrage of interference and surges of energy, therefore to disregard the need for simple, effective and reliable surge protection is to compromise the safety of the plant. Eaton's MTL surge protection devices provide protection both at the controller and at the field-mounted instrument, with specifically designed devices suitable for all data and signal requirements.



Power surge protection

Surges and spikes from nearby lightning strikes, arc-welders and high voltage cables can destroy or disrupt unprotected electronic equipment. These destructive forces enter mains power circuits within buildings by a variety of methods. The primary route is where power, often "dirty" and spike-laden, actually enters the building and it is at this point that surges should be stopped in order to prevent them from propagating further. However, surges and RFI can also corrupt mains power supplies from within the building. By providing protection at the main power distribution board and then at each piece of equipment, mains-borne surges and spikes are eliminated before they can cause damage.



LED Light surge protection

LS range is a compact SPD for LED lighting systems. Available in 277V,347V and 480V with a current rating of 5A for series version and unlimited for parallel version. The LS05K, LS10N and LS20N range is UL1449, 4th edition recognized component and selected models meet the "Enhanced" requirement of ANSI C136.2. LS range is compatible with IEC class I and class II luminaries.

- 10kA - 20kA surge protection per mode
- IP66 protection for outdoor application
- Models for both series and parallel connection.
- Selected models complies to the requirements of IEC61643-11 for T2+T3.



Network and comms surge protection

Network technologies from the internet to LANs have revolutionised the way businesses operate. From traffic control and sensing to the real-time status of a remote pumping station, industry relies on computer networks now more than ever. Network surge protection is essential if your business relies on IT services for its minute-to-minute operation. Eaton provides a complete line of ruggedised MTL network surge protection devices, including our ZoneBarrier high energy Ethernet range for 1000/100/10-Base-T applications, to protect the sensitive equipment in these harsh environments.



Specialist surge protection

With a wealth of experience in the design and manufacture of surge protection solutions for very specialised areas of application, Eaton can supply a range of superior MTL protection devices to meet your requirements, for wireless telecommunications, satellite, CCTV or general antenna protection. It is not just the obvious areas, such as mains power, networks and telecom systems that require protection - these specialist applications should not be overlooked.



Telecomms surge protection

Highly integrated, small signal telecommunications equipment is becoming increasingly sensitive to damage and disruption from voltage surges and spikes. It makes sense to protect expensive telephone installations from damage and commercially damaging downtime by fitting effective and unobtrusive protection wherever surges could enter the system. We can supply that protection, whether for private wire or public switched telephone network (PSTN) requirements and with a range of mounting and enclosure types to suit all applications.



MTL HMI and visualisation



Many industries now prefer to site their operator terminals and Human-Machine Interfaces (HMIs) on the plant or rig floor. MTL visualisation platforms include both the MTL GECMA and AZONIX ranges of ruggedised and extended temperature range workstations and data acquisition systems. All of which are suitable for both hazardous and non-hazardous area mounting, including Ex zone 1/2/21/22.

The MTL GECMA range of HMIs are home to the flexible modular concept consisting of

intrinsically safe components and the deliberate selection of high-quality materials. This allows the new MTL GECMA Work Station - a new generation of remote operating terminals - to be used under the strictest of hygienic conditions as well as in aggressive production environments. Even under extreme temperature conditions there is no functional impairment.

The AZONIX range of rugged HMIs and data acquisition systems are suitable to take on the challenging environment

of the rig-floor. Performing in extreme environmental conditions outdoors from the Alaskan slopes to the deserts of the Middle East. The platforms include the industry recognised Barracuda and ProPanel® range of hazardous area workstations certified for zone 2 applications.

The MTL GECMA and AZONIX product portfolio have been developed with over 25 years of experience in the design and manufacture of HMIs for harsh, hazardous and industrial environments.

Featured product

NEW

MTL GECMA Work Station Industrial range

The unique MTL GECMA Work Station product range welcomes new members to its family

The range will include a wide variety of versions:

- MTL GECMA Work Station Industrial RT
- MTL GECMA Work Station Industrial TC
- MTL GECMA Work Station Industrial PC
- MTL GECMA Work Station Industrial Flex-Line

The MTL GECMA Work Station Industrial range is an operating terminal designed to enhance visualization within your process using high resolution display options of 19", 22" or 24". They can be specified for use as a Remote Terminal, Thin Client or Personal Computer within the strictest of hygienic conditions, aggressive indoor and outdoor production environments areas typically found in pharmaceutical, chemical, biotech, oil & gas and off-shore manufacturing.

A key feature is the new slimline IP66 stainless steel housing design which makes it the ideal platform to serve the demands of clean and harsh environments.

The new MTL GECMA Work Station Industrial Flex-Line offers Flexibility without constraints, select you hardware of choice to ensure 100% compatibility with your application.

More detailed MTL GECMA and Azonix product information in separate, comprehensive catalogues or datasheets are available from your local Eaton office, or via our website at www.mtl-inst.com



MTL GECMA Work Station Industrial range

MTL GECMA Work Station Industrial Flex-Line display module

MTL GECMA Work Station Industrial range

- Available Technologies: RT(KVM), TC and PC concept
- New slimline housing
- Stainless Steel IP66 dust and water proof design for hygienic and harsh environments
- Fan-less / no movable parts for long term reliability
- Touchscreen functionality
- Windows 10 OS pre-installed and updated
- Fibre optic or copper data transmission
- Universal switching solution up to 48 end-points on request
- Available as complete system or panel mount
- Mobile options and accessories on request

MTL GECMA Work Station Industrial Flex-Line display module

- Flexibility without constraints
- Select you hardware of choice to ensure 100% compatibility with your applications
- Modular concept for efficient maintenance
- Stainless Steel IP66 water and dust proof proof design for hygienic and harsh environments
- Touch screen functionality
- Display sizes: 19", 22" and 24"
- Wide variety of Stainless Steel housings and mounting options available
- Barcode scanner / additional accessories on request
- Backwards compatible to existing GECMA Industrial installations
- Integrated Media fibre optic converter on request

Featured product

MTL GECMA Work Station Zone 1 Remote Terminals

Reducing your plant costs
Optimising your productivity
Increasing your plant safety

New generation of remote operating terminals

Introducing a new and unique modular design concept, the MTL GECMA Work Station (WS).

The MTL GECMA WS has been designed to address the environmental challenges of obtaining visualisation within harsh and hazardous areas.

Packed full of features and state-of-the-art technology the range includes Remote Terminal (RT), Thin Client (TC) and Personal Computer (PC) to meet a wide variety of applications. Suitable for the strictest of hygienic conditions and aggressive production environments, with a slim, flexible modular construction including individually certified modules to allow safe maintenance in hazardous areas.

The new MTL GECMA WS builds upon the significantly large installed base of its predecessors

and is now available as an upgrade for existing MTL GECMA Challenger and Explorer legacy installations.

- Platform, modular design concept
- Suitable for Ex zone 1/2/21/22
- Full HD, 16:9 for 22" and even larger for the 24" version
- Display options 19" - 24", in different resolutions
- Fibre optic or copper data transmission
- Highest dependability
- Future proof 'transparent' USB interface
- Savings of software licence costs
- Ex-approvals



MTL GECMA Work Station

MTL GECMA RT

Remote Terminal (RT)

Eaton's MTL GECMA RT is a keyboard, video and mouse (KVM) extension of either a safe area Personal Computer or Thin Client and can be installed into Ex zone 1/2/21/22 hazardous areas.

Providing a user-friendly, near real-time solution that enables a safe area PC or Thin Client to be remotely controlled from the hazardous area, via a single, point-to-point connection.

It comprises of the individually Ex certified components from our innovative, modular MTL GECMA Work Station range, with the addition of a Remote Terminal (RT) communication module and Safe Area Unit (SAU), delivering a wealth of great features and values specifically for your application.

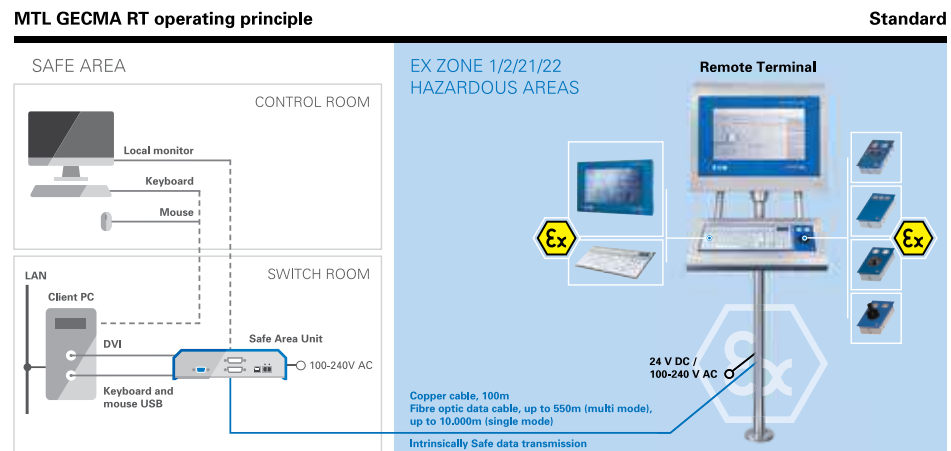

Thin Client (TC)

Eaton's MTL GECMA TC is specifically designed for virtualisation applications in Ex zones 1/2/21/22 hazardous areas.

It provides a powerful and reliable 'client' solution for integration into a Distributed Control System. Incorporating a Quad Core 2GHz CPU, 4GB RAM, numerous Ex i and Ex e connections and with a standard 'Windows-based' open operating system and remote-access software.

The MTL GECMA TC comprises of the individually Ex certified components from our innovative, modular MTL GECMA Work Station range. The simple addition of a TC communication (COM) module is then added to deliver a Thin Client solution.

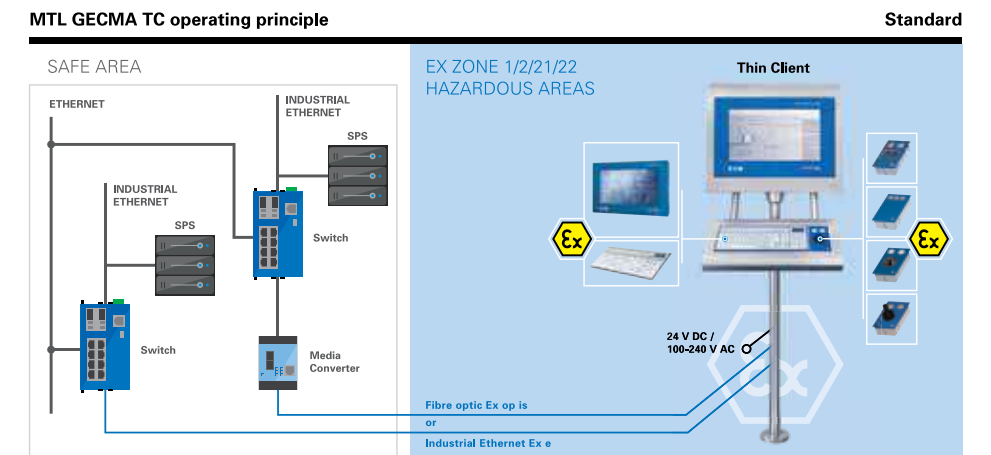

Innovative human-machine interfaces for on-site operation and local visualisation



MTL GECMA TC

MTL GECMA PC

Personal Computer (PC)

Eaton's MTL GECMA PC provides a powerful, flexible, stand-alone solution and is specified for use in Ex zone 1/2/21/22 hazardous areas.

Comprising of the individually Ex certified components from our modular MTL GECMA Work Station, with the addition of a PC communication (COM) module and available with a copper or fibre (Multi Mode or Single Mode) connection for a reliable transfer of data across longer distances.

Numerous Ex i and Ex e connections are available, allowing easy integration of locally connected devices such as barcode scanners and card readers. A dual Ethernet port provides redundancy on the network connection increasing client's network availability.

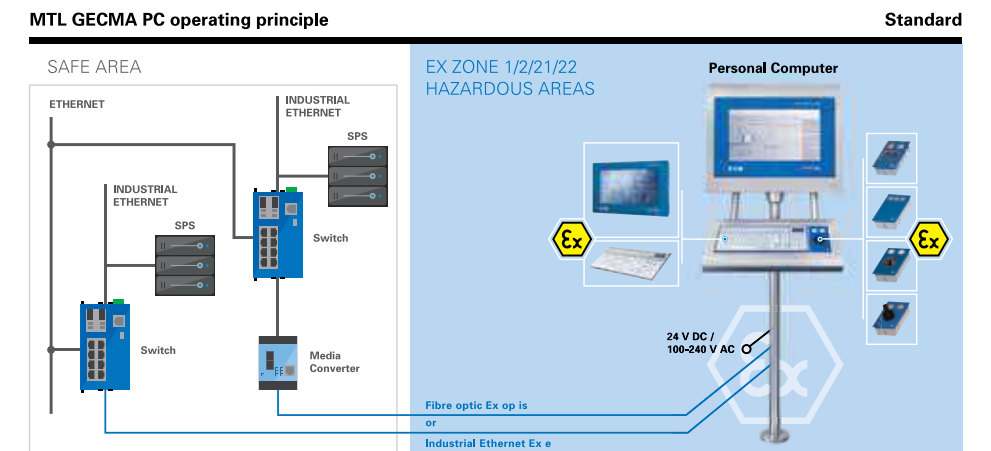

MTL enclosures and accessories for our MTL GECMA HMI range

Standard enclosures/mountings

The universal housing system used across the MTL GECMA WS range of units is the FHP standard enclosure. Our mounting components, stand STF and elbow pipe EBF, together with the MB coupling provide a universal method for simple and secure fastening. Both in base/wall and ceiling orientations, our HMIs can be mounted quickly, using only a few screws. The special MB coupling is manufactured as a one-piece item and allows rotation up to 300°, thus making optimum operation and visualisation possible.

- Hygienic, ergonomic field desk enclosure
- Designed to accommodate the display, keyboard, mouse or trackball
- Keyboard inclined by 30°
- Protection system IP 66
- Stainless Steel 1.4301 (1.4404/316L opt.)
- Polished to 240 granulation (or better on request)



Custom enclosures

The MTL GECMA WS modular concept enables application in a wide variety of special and customised housings. Our in-house engineering department will assist customers in achieving the optimum housing solution to suit their particular working environment, e.g. limited space, integration of various control elements, special resistant housing surfaces, integration into wall, cabinets and current housings.

Our extensive knowledge of HMIs in hazardous areas allows us to optimise the design to best suit the customer's application in hazardous, clean room and any particular demanding environment.

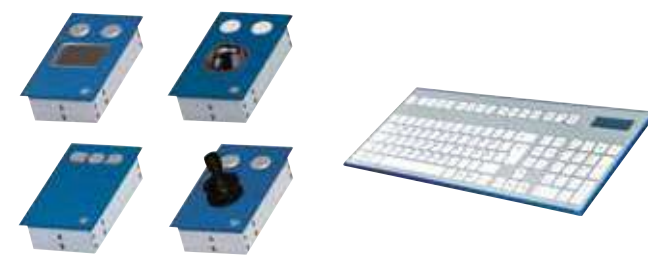

Accessories

A comprehensive range of accessories and options are available for the MTL GECMA WS range that can support and optimise customer's individual processes and plant requirements.

Whether you have a requirement to interface to the IT world outside of the hazardous area by wireless communication, ensure access control, select the optimum ergonomic input device and display option for your demanding environment, enable easy hardware based file transfer, or interface external input devices like barcode scanners, Eaton's original MTL accessories and options are approved in various hazardous areas.

MTL zone 2 workstations

AZONIX Barracuda 15 and 19 WS



Rugged Zone 2 workstation

The AZONIX Barracuda can be utilised in rig floor applications such as MWD / LWD, mudlogging or well stimulation in oil and gas operations where a display or workstation must be able to withstand harsh shock and vibration and meet hazardous area certification. The system's small footprint and VESA hole pattern allows for easy mounting in space-constrained work areas, making it equally suitable for use in machine automation environments where a standalone system must be mountable to various surfaces, from a standard pedestal to a boom, pole or custom panel mounting.

The AZONIX Barracuda is available in several configurations, depending on industry and specific application requirements. The system offers a full military hardened MIL-STD 810FG and IP66 compliant sunlight-readable touch-screen display. The AZONIX Barracuda incorporates an Intel® Core™ i7 processor workstation that offers a removable SSD or compact flash storage and runs Microsoft Windows 7 operating system.

It is a portable, rugged controller/monitor that can be transported from site to site or easily mounted in permanent locations. The power, wireless and I/O signals connectivity are via connectors and not glands for fast rig-up/rig-down in difficult installation locations, eliminating cable cost and labor. This system allows the user to display real time data in the harsh environment of the process being monitored and make adjustments to it locally.

- New Intel® Core™ i7 2.5GHz processor
- New 15 & 19 inch, sunlight-readable display
- New glass base projected capacitive touchscreen
- New wide temperature range -40°C to +60°C
- New built-in high gain 802.11n wireless LAN
- IECEx C1Z2 / ATEX Zone 2 / AEx Class 1 Zone 2 approvals

Visualisation solutions for harsh and hazardous areas



More detailed MTL HMI and visualisation product information in separate, comprehensive catalogues or datasheets are available from your local Eaton office, or via our website at www.mtl-inst.com

MTL gas analysers and systems

With over 30 years of gas application experience, our installed base includes supplied equipment used in digester gas analysis, landfill gas monitoring, CDM verification, gas-to-grid, CHP engine protection and efficiency and flare stack monitoring.

Application specific analysers are our forte. Rather than modify an existing product, we have designed application specific analyser solutions for power stations, the chlor alkali industry and biogas plants. This approach ensures that every component is chosen for the job and performs accordingly.

Eaton's MTL Biogas range of application specific solutions are designed exclusively for purpose, making them quick and easy to specify, reducing installation and start-up costs, optimising plant productivity and increasing plant availability.

Zirconia and thermal conductivity sensors are manufactured in-house, thus each sensor is characterised individually. Electrochemical cells are conditioned in house and, in some cases, modified according to the application. As manufacturers of both sensors and analysers, Eaton maintain full control over the production process.

Process gas analysers for safe and hazardous area applications



30
YEARS OF GAS
EXPERIENCE

More detailed MTL gas analyser product information in separate, comprehensive catalogues or datasheets are available from your local Eaton office, or via our website at www.mtl-inst.com



MTL GIR6000



Next generation biogas analyser

The new MTL GIR6000 offers a unique modular platform concept that is quick and easy to customise with a choice of up to six gas modules. This allows the user to choose only the gas elements they wish to measure. Reducing plant start-up costs is easy with an integrated solution that optimises your productivity and increases your plant availability. Rugged, reliable and easy to maintain, the MTL GIR6000 is an IP65 weather-proof system and is ATEX certified for use in a zone 2 area for safety confidence.

Oxygen analysers



From low ppm to high %

The G1010 panel mount oxygen analyser with electrochemical cell options is used in a wide variety of industries and applications. ATEX certified configurations are available. Zirconia oxygen sensors have a rapid response and are usually more accurate at low ppm oxygen levels. The Z4010 is a rugged, transportable unit ideal for use at multiple points on a plant, e.g. air separation and gas blending applications. The Z1920C is designed with a catalytic reactor to measure fuel:air ratios in flame treatment and burner applications.

Katharometers



For hydrogen, helium, dissociated ammonia and inert gases

Eaton is a market leader in novel katharometer design employing established thermal conductivity principles. The K1550R panel mount analyser with remote sensor can be supplied in different configurations, either with barriers to mount the sensor in hazardous areas or with full ATEX housing. Hydrogen is often measured by this technique and compensation inputs can be provided for non-binary mixtures.

Multi-parameter analysers



Custom led, application specific products

The Eaton design department is experienced at solving customer led application demands as new markets evolve. Some recent examples include:

- KG1550 panel mount and KG6050 rugged portable units for both hydrogen and oxygen; parameters critical to some biomass applications.
- GIR250 bench top unit for oxygen and carbon dioxide is used in fermentation monitoring, sports science and modified atmosphere packing

Analysers

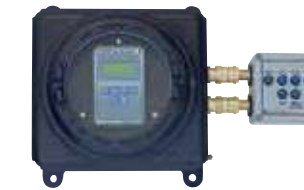

Fixed, portable, hazardous areas and OEM

Most analysers are available in a variety of configurations to suit customer demand. Panel mount, rack mount, wall mount and bench top options are offered as fixed units, while portable units are presented in rugged cases to extend lifetime in harsh plant conditions. For OEM customers and large PLC systems 'blind' transmitter versions are available. Eaton can respond quickly to solve application specific demands from all process industries.

Hydrogen and chlorine analysers



Hydrogen measurement in the chlorine manufacturing process

The KK650 is designed to measure both hydrogen and chlorine at all stages of the chlorine manufacturing process. Unique dual katharometer design even allows accurate, continuous measurement at start-up. The analyser is suitable for measuring at all stages of the chlor alkali process - 'wet' chlorine, 'dry' chlorine and tail gases. Custom design sample systems enable reliable measurement in 'wet' chlorine. Low maintenance and no consumables result in low cost of ownership.

Alternator purge gas monitors



Hydrogen purity and purge cycle analysers for power stations

Even small changes in hydrogen purity can affect the efficiency of turbogenerators significantly. For maintenance, the system needs to be purged carefully and efficiently to avoid the risk of explosive gas mixtures of hydrogen and air. Eaton's MTL alternator purge gas monitors are ideal for this application. The K1650 panel mount and K6050 rugged portable have three different ranges to measure hydrogen purity, hydrogen in air and carbon dioxide in air. Samples systems are available to regulate and calibrate pressurised systems.

Sensors



Zirconia, electrochemical, infrared and katharometers

Zirconia sensors and galvanic (electrochemical) cells are the two technologies used for oxygen measurement. A range of options are available for applications including low ppm levels, mildly acidic gases or hydrocarbons. Hydrogen sulphide is also measured with an electrochemical cell. Katharometers are thermal conductivity devices ideal for measurement in binary or pseudo-binary mixtures. Hydrogen, dissociated ammonia, sulphur hexafluoride, helium and other inert gases where no dedicated sensor exists, are ideal candidates for this method.

Sample conditioning systems

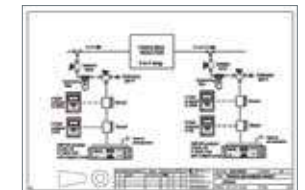

Bespoke systems for specific applications

Analysers and sensors depend heavily on the condition of sample supplied. Eaton supplies a number of MTL component parts - filters, flowmeters, regulators, pumps, etc - as well as bespoke sample conditioning systems designed for specific customer applications. Water vapour and particulate matter will routinely prevent accurate analysis but can easily be eliminated with careful choice of sample system. Application questionnaires ensure that all process parameters are fully considered.

MTL process alarm equipment

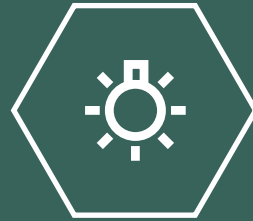

As a global supplier Eaton provides MTL alarm products for both safe and hazardous environments. Our alarm annunciators capture and display critical alarms with options to timestamp to 1mS resolution and transmit this data to third party devices over various protocols. Sequential events can also be recorded

within substation automation systems by using the MTL substation annunciator that utilises various protocols such as IEC61850 and DNP3.0. Eaton's MTL network annunciator uses the same protocols to display critical alarms as an intelligent lamp unit with features such as:

- Integral dual redundant PSU's
- Alarm events can be transmitted over IEC61850 and DNP3 protocols
- IEC61850 & DNP3.0 protocols can drive MTL annunciators for critical alarms
- SNPT synchronisation
- For safety instrumented systems also offer the SIL725, a unit that is certified to IEC61508

Alarm solutions to the worldwide process and power industries



Featured products

MTL annunciators

More detailed MTL process alarm product information in separate, comprehensive catalogues or datasheets are available from your local Eaton office, or via our website at www.mtl-inst.com

RTK SmartAlarm annunciator

Alarm annunciators

Eaton are pleased to announce an alarm annunciator family in the popular DIN package size. The RTK SmartAlarm brings together many years of development in alarm annunciator technology and builds on the functionality of the field proven RTK UC625. The RTK SmartAlarm is designed as a complete alarm system with integral, audible, relays and pushbuttons for the most cost effective solution for monitoring critical process alarms. Incorporating ISA 18-1 1979 (R1992) alarm sequence programmable via the front panel

mounted USB connector, the unit also accommodates optional signal duplicating relays, dual horn relays and LED display, making the RTK SmartAlarm an ideal choice where full functionality is required and space is a premium.

- DIN size module with 8, 16, 24, 32 channel versions
- Internal FCV 24VDC
- Pluggable LED's in five colours, red, yellow, white, blue and green
- Internal logic PSU
- Remote pushbuttons mapped to P/B function



MTL annunciators and event recorders



Used to monitor critical alarms our MTL alarm annunciators are all designed as modular products, manufactured to your exact needs with a range of options added as required.

The range includes products for all hazardous areas and also the RTK SIL725 annunciator certified to IEC61508 at SIL2 level for use as part of a safety instrumented system.

Units can be supplied as pure event recorders to time-stamp events to 1ms or as a combined event recorder/alarm annunciator.

MTL hazardous area notification



Operators working within a hazardous area need to be quickly and clearly informed of any potential hazard, Eaton's MTL. Eaton's PEX7250 Exd hazardous area annunciator is designed to work in all zones, allowing operators to visualize critical alarms locally.

External hazardous area sounders can be provided with programmable tones and outputs in excess of 100dB to aid notification of critical alarm activation

MTL engineered solutions



Many clients require more than the simple supply of loose products. Our experienced team of engineers can provide a consultancy service to help these clients select the most appropriate solution. These solutions can consist of any intrinsically safe or explosion proof system or a custom alarm or event recording system. Our team will manage each project throughout its life-cycle from design, through client approval to production where the complete system, including any software, is fabricated and wired. The finished package, with all agreed documentation, is then ready for the Factory Acceptance Test prior to shipment to site. Commissioning and training can also be provided if required.



Functional Safety Management



Many Eaton MTL products are certified as safe for use in hazardous areas, where explosive material may be present. The products are designed and certified to show that they are incapable of igniting the gas or dust and causing fire or explosion.

Another type of safety is called **Functional Safety**, which applies when products are used in safety and protection systems, in which a failure may mean that a protective system will not operate as it should. Our MTL product range has been used in safety systems for some time, but there are increasing requirements to demonstrate an adequate level

of functional safety, especially after the Buncefield, Texas City and Deepwater Horizon accidents. More and more, customers are demanding that products they use in safety systems meet the requirements of the second edition of the **IEC 61508 Functional Safety** standard, and they require evidence to show that they do. This is to enable the use of our products within instrumentation loops that are designed to achieve a specific Safety Integrity Level (SIL).

When we design a product in the expectation that it will be used in functional safety-related systems, both the design process and the

product needs to comply with IEC 61508:2010.

Eaton has chosen to obtain Functional Safety Management (FSM) certification for the Eaton Electric facility in Luton, UK. FSM means that we have the necessary processes and competence to design products according to IEC 61508:2010. Certification means that a notified body is ensuring that our processes are correct and that we are working to them. Together, FSM certification gives our customers confidence in the company and the use of our products for functional safety.

FSM product range

Eaton continues to expand its Functional Safety offering with a range of MTL products already assessed as suitable for use in or with safety loops. These include:

MTL intrinsically safe interfaces

MTL4500 and MTL5500 ranges of intrinsically safe isolators.



MTL signal surge protection

TPxx range (field mounted) and Sxx range (DIN-rail mounted) surge protection.



MTL asset management instrumentation

MTL4850 HART® SIL 3 multiplexer for use with safety systems.



MTL alarm annunciator equipment

RTK SIL725 safety annunciator.



Certificate No. CASS 00015/01



We were the first supplier of process instrumentation to be certified as a Functional Safety Management (FSM) company

MTL product stewardship

We believe that we owe it to future generations to leave the world a little greener, and that the power to make that happen is in our hands.

We are working towards operating more efficiently and sustainably, and we're helping our customers do the same.

With a clear environmental management strategy, we take responsibility for minimising our product's environmental impact throughout all stages of its life cycle, including end-of-life management.

We commit to minimise the impact of our operations and products on the environment



Sustainability

We make a healthy planet work

Life Cycle Assessment (LCA)

Being responsible for the environment is part of the product design process at Eaton. The principles of Life Cycle Assessment (LCA) are followed to gather information about the potential environmental impact of new MTL products throughout their lifecycle, taking into account energy efficiency, resource efficiency, recycling and compliance with regulations.



REACH

This regulation applies to all electrical products and aims to reduce the use of hazardous chemicals in manufacturing. We are constantly monitoring the use of substances that fall under the REACH regulations in our manufacturing processes. To the best of our knowledge, our products do not contain SVHCs (Substances of Very High Concern) and if those substances are ever discovered above the threshold limit we will communicate it to our customers as required.

ISO, RoHS and WEEE

Eaton manufacturing facilities voluntarily follow the international standards outlined by ISO 9001 and are ISO 14001 compliant with Environmental Management standards. This ensures quality, environmental friendliness, safety, reliability, efficiency and interchangeability – and at an economical cost.

Eaton is also compliant, where applicable, to RoHS and WEEE. The Restriction of Hazardous Substances (RoHS) and Waste Electrical and Electronic Equipment (WEEE) initiatives were designed to limit the presence of hazardous chemicals in landfills and regulate the use of certain materials.



Making compliance information easy to find

Many multi-national organisations now have a policy of "Buy anywhere and use everywhere", and need evidence that the products they buy meet the relevant environmental laws in the intended country of use. Environmental compliance information for MTL products is therefore available in the downloads section of the MTL products website, making it easy for our customers to find the compliance status at the point of ordering.



MTL services and support

Providing instant value to your project with services tailored to your needs

With our years of experience in intrinsic safety, functional safety and FOUNDATION™ fieldbus, our team can provide instant value to your project - at any time in its lifecycle from Front End Engineering Design (FEED) to construction and commissioning right through to post-project network integrity maintenance.

Getting it right from the start is the key to the success of any

project and we are here to help you select the right solution for your applications. Regardless of whether you are designing a "traditional" analogue system, HART® based system or a complete digital system incorporating FOUNDATION™ fieldbus, industrial Ethernet or wireless, Eaton can assist with project definition, network services and knowledge capture.

With our global network of sales associates, help is never far away. Our local professional sales teams continue to be your interface to the complete organisation, helping you get your project completed on budget and on time, with real and sustainable benefits.



Learn with Eaton

Why educate?

Education is essential in today's workplace to...

- Replace skills and experience lost through retirement and workforce reduction
- Reduce reliance on costly external expertise and consultancy
- Enable multi-skilling of employees
- Promote continuous vocational learning
- Empower individuals to become effective professionals

Eaton can help fill the skills gap by providing training across a wide range of technical subjects, and using a variety of training media.

Training to suit your needs and budget

Decades of experience in designing MTL instrumentation products for process control applications contribute to Eaton's training and education resources. Free-of-charge "Lunch and Learn" seminars are available in many regions, and chargeable full-day training courses can be arranged on request.

Live, internet-based webinars can also be staged for teams working across diverse geographies or time zones.

From technology through to application

Training materials are available to cover the full scope of Eaton's MTL products, and include:

- Explosion protection of electrical apparatus in flammable atmospheres
- Intrinsic safety design and installation
- FOUNDATION™ fieldbus connectivity and diagnostics
- Cyber security for process control
- Functional safety
- Industrial Ethernet, including intrinsically safe Ethernet solutions
- Surge protection

...plus a range of allied subjects and product-specific content.

So why not explore how Eaton can help develop your workforce? Contact your nearest Eaton office to discuss your training requirements





EATON MTL products

The safety you rely on.

See the complete MTL product portfolio at www.mtl-inst.com

U.S. (Global Headquarters):
Eaton's Crouse-Hinds Business
1201 Wolf Street
Syracuse, NY 13208

(866) 764-5454
FAX: (315) 477-5179
FAX Orders Only:
(866) 653-0640

CrouseCustomerCTR@Eaton.com

For more information:

If further assistance is required, please contact an authorised MTL Distributor, Sales Office, or Customer Service Department

AUSTRALIA

MTL Instruments Pty Ltd,
10 Kent Road, Mascot, New South Wales, 2020, Australia
Tel: +61 1300 308 374 Fax: +61 1300 308 463
E-mail: mtlsalesanz@eaton.com

BeNeLux

MTL Instruments BV
Ambacht 6, 5301 KW Zaltbommel
The Netherlands
Tel: +31 (0)418 570290 Fax: +31 (0)418 541044
E-mail: mtl.benelux@eaton.com

CHINA

Cooper Electric (Shanghai) Co. Ltd
955 Shengli Road, Heqing Industrial Park
Pudong New Area, Shanghai 201201
Tel: +86 21 2899 3600 Fax: +86 21 6353 9756
E-mail: mtl-cn@eaton.com

FRANCE

MTL Instruments sarl,
7 rue des Rosieristes, 69410 Champagne au Mont d'Or
France
Tel: +33 (0)4 37 46 16 53 Fax: +33 (0)4 37 46 17 20
E-mail: mtlfrance@eaton.com

GERMANY

MTL Instruments GmbH,
Heinrich-Hertz-Str. 12, 50170 Kerpen, Germany
Tel: +49 (0)22 73 98 12 - 0 Fax: +49 (0)22 73 98 12 - 2 00
E-mail: csckerpen@eaton.com

INDIA

MTL India,
No.36, Nehru Street, Off Old Mahabalipuram Road
Sholinganallur, Chennai - 600 119, India
Tel: +91 (0) 44 24501660 /24501857 Fax: +91 (0) 44 24501463
E-mail: mtlindiasales@eaton.com

ITALY

MTL Italia srl,
Via San Bovio, 3, 20090 Segrate, Milano, Italy
Tel: +39 02 959501 Fax: +39 02 95950759
E-mail: ItalyOrders-Enquiries@Eaton.com

JAPAN

Cooper Crouse-Hinds Japan KK,
MT Building 3F, 2-7-5 Shiba Daimon, Minato-ku,
Tokyo, Japan 105-0012
Tel: +81 (0)3 6430 3128 Fax: +81 (0)3 6430 3129
E-mail: mtl-jp@eaton.com

NORWAY

Norex AS
Fekjan 7c, Postboks 147,
N-1378 Nesbru, Norway
Tel: +47 66 77 43 80 Fax: +47 66 84 55 33
E-mail: info@norex.no

RUSSIA

Cooper Industries Russia LLC
Elektrozavodskaya Str 33
Building 4
Moscow 107076, Russia
Tel: +7 (495) 981 3770 Fax: +7 (495) 981 3771
E-mail: mtlrussia@eaton.com

SINGAPORE

Cooper Crouse-Hinds Pte Ltd
100G Pasir Panjang Road, Interlocal Centre
#07-08 Singapore 118523
Tel: +65 6645 9888 Fax: +65 6645 9811
E-mail: sales.mtlsing@eaton.com

SOUTH KOREA

Cooper Crouse-Hinds Korea
7F. Parkland Building 237-11 Nonhyun-dong Gangnam-gu,
Seoul 135-546, South Korea.
Tel: +82 6380 4809 Fax: +82 6380 4839
E-mail: mtl-korea@eaton.com

UNITED ARAB EMIRATES

Cooper Industries/Eaton Corporation
Office 205/206, 2nd Floor SJ Towers, off. Old Airport Road,
Abu Dhabi, United Arab Emirates
Tel: +971 2 44 66 840 Fax: +971 2 44 66 841
E-mail: mtlgulf@eaton.com

UNITED KINGDOM

Eaton Electric Ltd,
Great Marlings, Butterfield, Luton
Beds LU2 8DL
Tel: +44 (0)1582 723633 Fax: +44 (0)1582 422283
E-mail: mtlenquiry@eaton.com

AMERICAS

Cooper Crouse-Hinds MTL Inc.
3413 N. Sam Houston Parkway W.
Suite 200, Houston TX 77066, USA
Tel: +1 281-571-8065 Fax: +1 281-571-8069
E-mail: mtl-us-info@eaton.com

Eaton Electric Ltd,
Great Marlings, Butterfield, Luton
Beds LU2 8DL, UK.
Tel: + 44 (0)1582 723633 Fax: + 44 (0)1582 422283
E-mail: mtlenquiry@eaton.com

www.mtl-inst.com



© 2020 Eaton
All Rights Reserved
ZL-C-PROV-EN-0620
Jun 2020

Eaton Electric Limited,
Great Marlings, Butterfield, Luton
Beds, LU2 8DL, UK.
Tel: + 44 (0)1582 723633 Fax: + 44 (0)1582 422283
E-mail: mtlenquiry@eaton.com
www.mtl-inst.com

Eaton is a registered trademark.
All other trademarks are property
of their respective owners.

Connect with Eaton, MTL:

